

YAMAHA AST-A90M

Natural Sound Active Servo Processing Amplifier

CENTER



CONTENTS

Safety Instructions	1
Precautions	2
AST System	3
Connections Diagram	4
System Connections	5
Connection Procedures	5
Controls and Indicators	8

OWNER'S MANUAL

Remote Control Transmitter	9
Operations	11
Using the Remote Control Transmitter	11
How to Use the Learning Function	13
Troubleshooting	16
Specifications	18

SAFETY INSTRUCTIONS

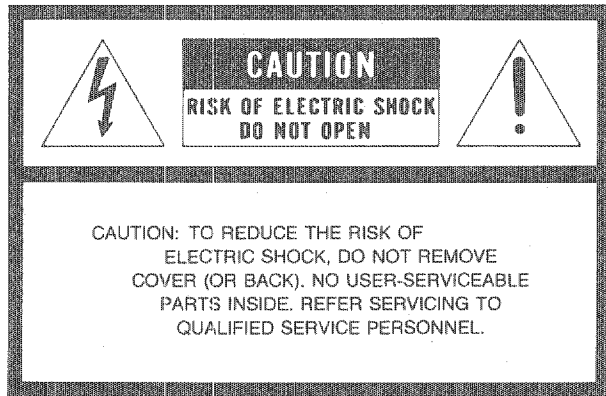

• Explanation of Graphical Symbols

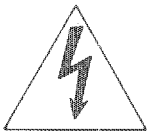

The lightning flash with arrowhead symbol, within an equilateral triangle, is intended to alert you to the presence of uninsulated "dangerous voltage" within the product's enclosure that may be of sufficient magnitude to constitute a risk of electric shock to persons.

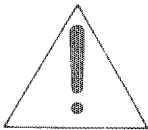

The exclamation point within an equilateral triangle is intended to alert you to the presence of important operating and maintenance (servicing) instructions in the literature accompanying the appliance.

WARNING

To reduce the risk of fire or electric shock, do not expose this appliance to rain or moisture.

1 Read Instructions – All the safety and operating instructions should be read before the appliance is operated.

2 Retain Instructions – The safety and operating instructions should be retained for future.

3 Heed Warnings – All warnings on the appliance and in the operating instructions should be adhered to.

4 Follow Instructions – All operating and other instructions should be followed.

5 Water and Moisture – The appliance should not be used near water – for example, near a bathtub, washbowl, kitchen sink, laundry tub, in a wet basement, or near a swimming pool, etc.

6 Carts and Stands – The appliance should be used only with a cart or stand that is recommended by the manufacturer.

6A An appliance and cart combination should be moved with care. Quick stops, excessive force, and uneven surfaces may cause the appliance and cart combination to overturn.



7 Wall or Ceiling Mounting – The appliance should be mounted to a wall or ceiling only as recommended by the manufacturer.

8 Ventilation – The appliance should be situated so that its location or position does not interfere with its proper ventilation. For example, the appliance should not be situated on a bed, sofa, rug, or similar surface, that may block the ventilation openings; or cabinet that may impede the flow of air through the ventilation openings.

9 Heat – The appliance should be situated away from heat sources such as radiators, stoves, or other appliances that produce heat.

10 Power Sources – The appliance should be connected to a power supply only of the type described in the operating instructions or as marked on the appliance.

11 Power-Cord protection – Power-supply cords should be routed so that they are not likely to be walked on or pinched by items placed upon or against them, paying particular attention to cords at plugs, convenience receptacles, and the point where they exit from the appliance.

12 Cleaning – The appliance should be cleaned only as recommended by the manufacturer.

13 Nonuse Periods – The power cord on the appliance should be unplugged from the outlet when left unused for a long period of time.

14 Object and Liquid Entry – Care should be taken so that objects do not fall into and liquids are not spilled into the inside of the appliance.

15 Damage Requiring Service – The appliance should be serviced by qualified service personnel when:

- A.** The power-supply cord or the plug has been damaged; or
- B.** Objects have fallen, or liquid has been spilled into the appliance; or
- C.** The appliance has been exposed to rain; or
- D.** The appliance does not appear to operate normally or exhibits a marked change in performance; or
- E.** The appliance has been dropped, or the cabinet damaged.

16 Servicing – The user should not attempt to service the appliance beyond those means described in the operating instructions, all other servicing should be referred to qualified service personnel.

17 Power Lines – An outdoor antenna should be located away from lines.

18 Grounding or Polarization – The precautions that should be taken so that the grounding or polarization of an appliance is not defeated.

PRECAUTIONS

- Unpack the unit carefully and make sure that the following attached items are included.

1. Owner's Manual	1
2. Learning Remote Control Transmitter	1
3. Batteries (size "AA", R06)	4
4. AST cartridge (AST-K90M)	1

- Owner's Manual

To ensure proper operation, it is necessary to read the manual carefully before use. Keep in safe place after reading for future reference.

- Layout/Positioning

Install unit in a cool, dry, and clean keep away from windows against direct sunlight, near heated source, and moisture.

- Never remove the cover of this unit

Do not remove the cover for your safety. Check the **TROUBLESHOOTING** section should malfunction exist. Unplug the power cord and contact the retail store where purchased; should the malfunction persist. Do not attempt service of this unit personally.

- When Moving

Do not exert pressure on switches or knobs when carrying. When moving the unit, first disconnect the power plug and the cords connected to the unit.

- When malfunction exists

First check the **TROUBLESHOOTING** section. Unplug the power cord and contact the retail store where purchased, should the malfunction persist.

- Cleaning

Wipe with a dry soft cloth to remove dust. Do not use chemicals solvents such as alcohol and thinner to clean the unit. Panel finish may be damaged.

Special Instructions for U.K. Model

IMPORTANT

The wires in the mains lead are coloured in accordance with the following code:

Blue: NEUTRAL

Brown: LIVE

As the colours of the wires in the mains lead of this apparatus may not correspond with the coloured markings identifying the terminals in your plug, proceed as follows. The wire which is coloured BLUE must be connected to the terminal which is marked with the letter N or coloured BLACK. The wire which is coloured BROWN must be connected to the terminals which is marked with the letter L or coloured RED.

VOLTAGE SELECTOR (for General Model)

The voltage selector on the rear panel of the AST-A90M must be set for your local voltage BEFORE plugging in the AC mains supply. Voltages are 110/120/220/240 V AC, 50/60 Hz.

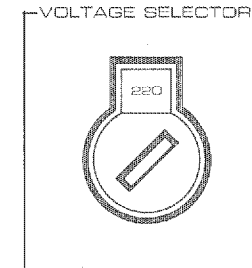

FOR CANADIAN CUSTOMER

THIS DIGITAL APPARATUS DOES NOT EXCEED THE "CLASS B" LIMITS FOR RADIO NOISE EMISSIONS FROM DIGITAL APPARATUS SET OUT IN THE RADIO INTERFERENCE REGULATION OF THE CANADIAN DEPARTMENT OF COMMUNICATIONS.

Thank you for purchasing the YAMAHA Processing Amplifier AST-A90M. In order to ensure proper operation for the best possible performance, please read this manual thoroughly before connecting up your new amplifier and turning it on.

IMPORTANT!

Please record the serial number of your unit in the space below.

Model: AST-A90M

Serial No.:

The AST-A90M unlike any existing amplifier, is an amplifier that can have a negative resistance figure in its output impedance. The voice coil impedance of a conventional speaker is approximately 6Ω , and the AST-A90M can apply a negative resistance to eliminate this voice coil resistance portion. As a result, with the combination of the AST-A90M and the AST System exclusive speakers (AST-SV90, etc.), the resistance between the amplifier and speakers will become approximately 0Ω and the electrical current will be able to run infinitely (condition close to superconductivity). In other words, the amplifier output voltage will directly drive the speakers, hence making it possible to provide a powerful driving force and damping power of steady speed operation.

Because an element possessing a negative resistance figure does not exist in nature, we have developed this by way of electrical circuits in the AST-A90M. If the type of speakers varies, the negative resistance figure will be different. Accordingly, we have developed the negative resistance producing circuit into a cartridge form to apply to various AST speakers.

In addition, with the utilization of the Air Woofer system in which the air in the port functions as a diaphragm, the distortion is considerably retained in the low range to enable high-quality enjoyment of bass.

CONNECTIONS DIAGRAM

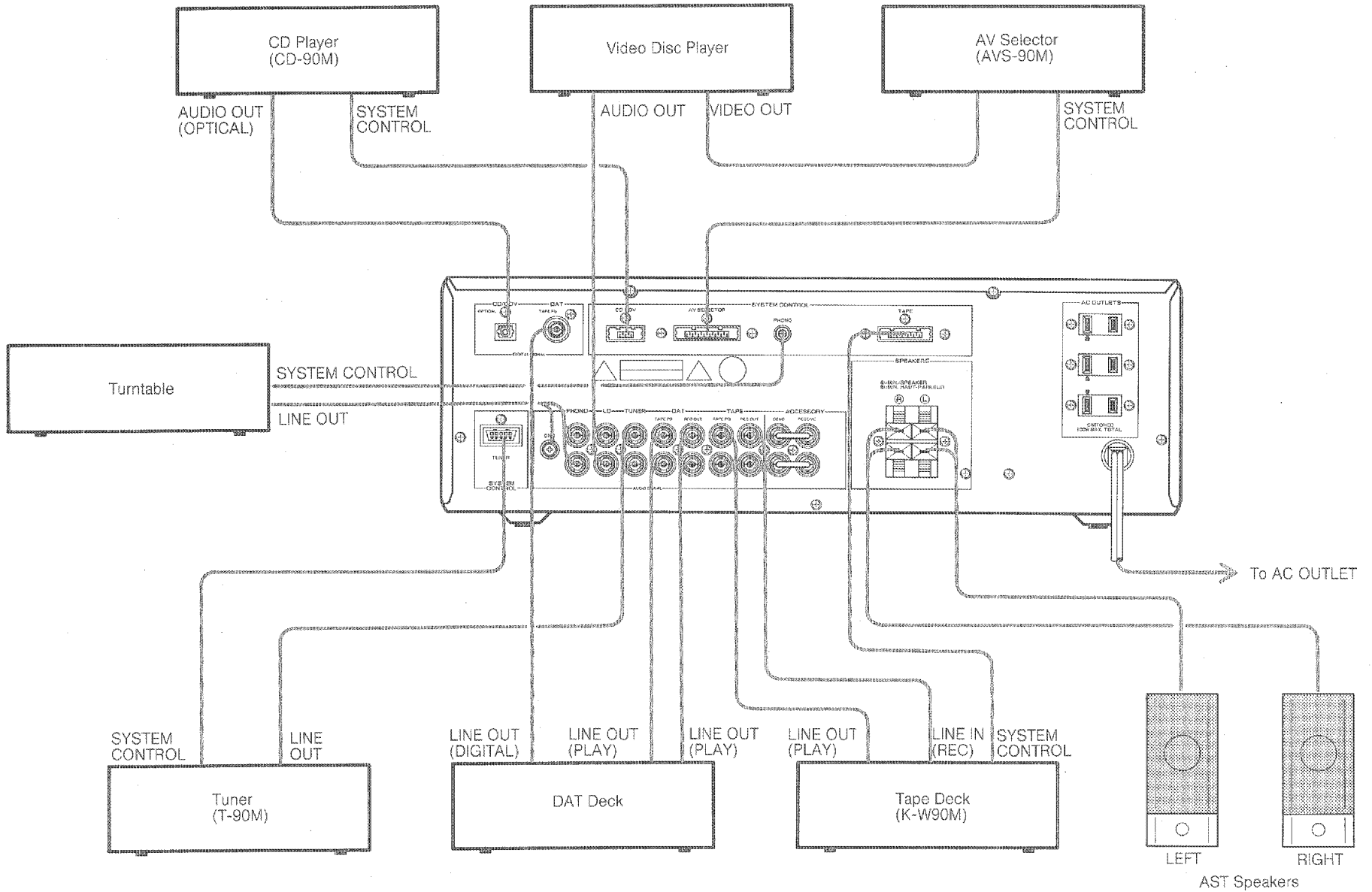

SYSTEM CONNECTIONS

Caution when Connecting

- Switch power of all units OFF.
- Make sure to correctly connect pin-plug cord to left channel (L) and right channel (R) of each unit respectively.
- Connect power cord after all connections are completed.
- Install AST cartridge (attached to AST speaker) in cartridge holder on the front panel of this section when connecting with AST speakers. The AST cartridge will vary according to the AST speakers to be used, therefore install the proper cartridge attached to the speakers to be used. When connecting with conventional speakers, insert AST cartridge (AST-K90M) (attached to this unit) in cartridge holder.

AC OUTLETS

The AC OUTLETS is found on the rear panel and supplies power to other audio units.

The AC OUTLETS is interlocking with the POWER switch of this unit. Simultaneous POWER ON/OFF of connected units is possible with the operation of POWER switch of this unit, when POWER switches of connected units are left ON. The AC OUTLETS can be connected to audio unit with power consumption of up to 100W.

CONNECTION PROCEDURES

■ Speaker Connection

Connect speaker to speaker terminal using speaker cord. Prepare speaker cords L, R and set connection cords as short as possible.

While pressing speaker terminal lever, insert speaker cord into terminal opening. Fix speaker cord after depressing lever. Next, lightly pull speaker cord to make sure that cord has been properly connected.

After connection, install AST cartridge (attached to AST speaker) in cartridge holder on the front panel of this unit. When connecting with conventional speakers, insert AST cartridge (AST-K90) (attached to this unit) in cartridge holder.

When connecting speakers, caution against incorrect L, R as well as +, - connections. If incorrectly connected, not only would there be no normal sound emitted, but damage to the speakers could also occur.

Do not place speaker cord one over the other or let it run near a power cord, as this will lead to deterioration of sound quality.

■ Turntable Connection

Connect turntable output cord to PHONO terminal. Then connect Ground wire to GND terminal.

Under normal conditions, connect Ground wire; however, disconnect Ground wire to obtain optimum results when hum noise is slightly emitted. In addition connect turntable output cord as far as possible from AC cord or transformers. When using P-90M for turntable, connect P-90M SYSTEM CONTROL:AMP terminal to SYSTEM CONTROL:PHONO terminal of this unit with system control cord (attached to P-90M). In addition, in this case, there is no need to connect the Ground wire.

■ CD player (CD-90M) Connection

Connect CD-90M AUDIO OUTPUT:OPTICAL terminal to CD/CDV:OPTICAL terminal of this unit with optical cable (attached to CD-90M).

Connect CD-90M SYSTEM CONTROL terminal to SYSTEM CONTROL:CD/CDV terminal of this unit with system control cord (attached to CD-90M).

■ VIDEO DISC player Connection

Connect video disc player AUDIO OUTPUT terminal to LD terminal of this unit with pin-plug cord. Connect player VIDEO OUTPUT to AV PROCESSOR (AVS-90M) or monitor etc.

■ Tuner Connection

Connect tuner output terminal to TUNER terminal of this unit with pin-plug cord. When using T-90M for tuner, connect T-90M SYSTEM CONTROL terminal to SYSTEM CONTROL:TUNER terminal of this unit with system control cord (attached to T-90M).

■ DAT Deck Connection

Connect DAT deck output terminal (LINE OUT/PLAY) to DAT:TAPE PB terminal of this unit with pin-plug cord.

Connect DAT deck input terminal (LINE IN/REC) to DAT:REC OUT terminal of this unit with pin-plug cord.

Connect DAT deck digital terminal to DIGITAL SIGNAL (DAT:TAPE PB) terminal of this unit.

■ Tape Deck Connection

Connect tape deck output terminal (LINE OUT/PLAY) to TAPE:TAPE PB terminal of this unit with pin-plug cord.

Connect tape deck input terminal (LINE IN/REC) to TAPE:REC OUT terminal of this unit with pin-plug cord.

When using K-W90M for tape deck, connect K-W90M SYSTEM CONTROL terminal to SYSTEM CONTROL:TAPE terminal of this unit with system control cord (attached to K-W90M).

■ AV PROCESSOR (AVS-90M) Connection

Connect AVS-90M SYSTEM CONTROL terminal to SYSTEM CONTROL:AV SELECTOR terminal of this unit with system control cord (attached to AVS-90M).

■ Graphic Equalizer Connection

Connect graphic equalizer to ACCESSORY terminal.

Remove jumper pin inserted into ACCESSORY terminal before connection.

Connect graphic equalizer LINE IN terminal to ACCESSORY:SEND terminal of this unit with pin-plug cord.

Connect graphic equalizer LINE OUT terminal to ACCESSORY:RECEIVE terminal of this unit with pin-plug cord.

CAUTION

Keep jumper pins in a safe place. Never connect the removed jumper pins to other terminals. This will lead to malfunction of the unit.

When nothing is connected to the ACCESSORY terminal, insert the jumper pins. If the jumper pins are not inserted, sound will not be emitted.

■ AST-A90M Unit

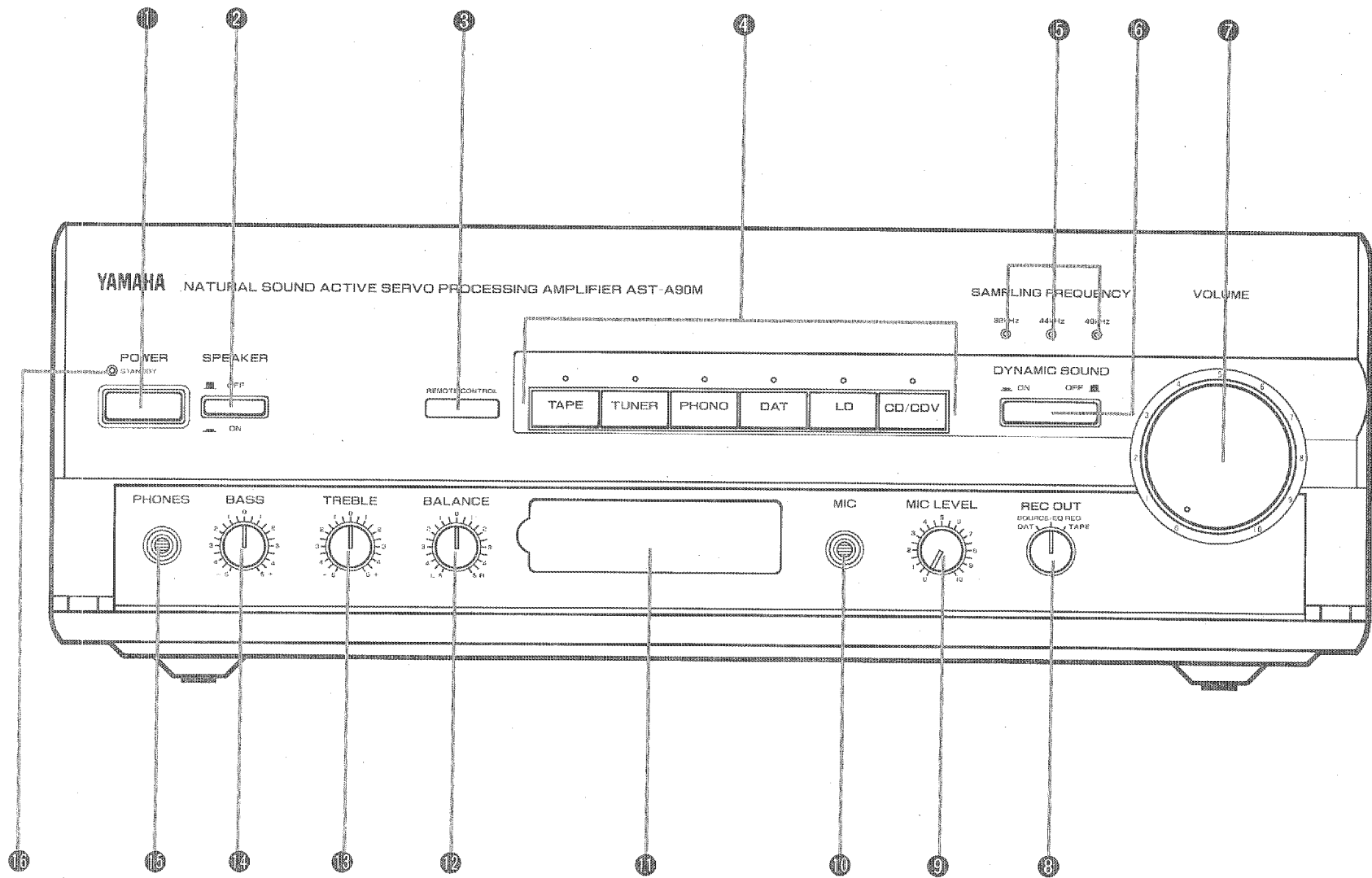

CONTROLS AND INDICATORS

❶ POWER switch (POWER)

This is a switch to turn power ON, OFF of this unit. When the switch is pressed, the power will be ON and the ❷ Standby indicator (STANDBY) will light. And when the switch is pressed again, the power will be turned OFF and the ❷ Standby indicator (STANDBY) will turn off.

Set volume to the lowest with ❸ Volume when turning power ON.

❷ Speaker switch (SPEAKERS)

Sound will emit from speakers connected to rear panel speaker terminals when this switch is turned ON. When turned OFF, sound will not emit. Turn switch OFF when enjoying headphones.

❸ Remote Control Sensor (REMOTE CONTROL)

This is the sensor receiving signals from the attached remote control when operating.

❹ Input selector

This is the button to select source to be listened to. The indicator of the selected source will light above the button.

❺ Sampling Frequency indicator (SAMPLING FREQUENCY)

The indicator will light according to source sampling frequency when the unit attached to the rear panel DIGITAL SIGNAL terminal is played.

❻ Dynamic Sound switch (DYNAMIC SOUND)

When this switch is turned ON when listening with low volume, bass as well as treble will be emphasized for easy listening.

❼ Volume (VOLUME)

This is the knob to control volume. When turned clockwise, volume is increased; when turned counterclockwise, volume is reduced.

Set volume to the lowest when turning power ON or when switching ❹ Input selector. This is to prevent destruction of unit by inadvertent emittance of loud volume.

❽ Rec Out selector (REC OUT)

Switch this selector when conducting tape dubbing. Position to DAT when dubbing from DAT deck to tape deck. Position to TAPE when dubbing from tape deck to DAT deck.

Position to SOURCE under normal conditions. Select source to be recorded with ❹ Input selector.

When using the graphic equalizer, position to SOURCE when recording sound with equalizer effect.

❾ Microphone Level Control knob (MIC LEVEL)

This is the knob to control volume of microphone connected to ❿ microphone jack. Sound that is mixed with microphone and source, is controlled with ❸ Volume.

❿ Microphone jack (MIC)

This is the jack to connect microphone into.

⓫ Cartridge Holder

Insert cartridge (attached to AST speaker) here. If cartridge is not inserted, sound will not emit.

Never fail to use specific cartridge attached to connected speakers.

Insert AST cartridge (AST-K90M: attached to this unit) when conventional speakers, other than AST speakers, is connected.

* Specific cartridges can be readily distinguished by common model-number endings of the AST cartridge and the AST speakers.

AST cartridge : AST-KSV90M

AST speakers : AST-SV90M

⓬ Balance Control knob (BALANCE)

This is the knob to control left/right volume balance.

⓭ Treble Control knob (TREBLE)

This is the knob to control treble. When turned clockwise, the treble is reinforced; when turned counter-clockwise, the treble is reduced. Position to the center where it clicks at (0) under normal conditions.

⓮ Bass Control knob (BASS)

This is the knob to control bass. When turned clockwise, the base is reinforced; when turned counter-clockwise, the bass is reduced. Position to the center where it clicks at (0) under normal conditions.

⓯ Phones jack (PHONES)

Connect to this jack when listening to separately sold stereo headphones. When listening only with headphones, turn ❷ Speaker switch OFF.

⓰ Standby indicator (STANDBY)

When the power is ON, this indicator will light and when the power is turned OFF, the indicator will turn OFF.

REMOTE CONTROL TRANSMITTER

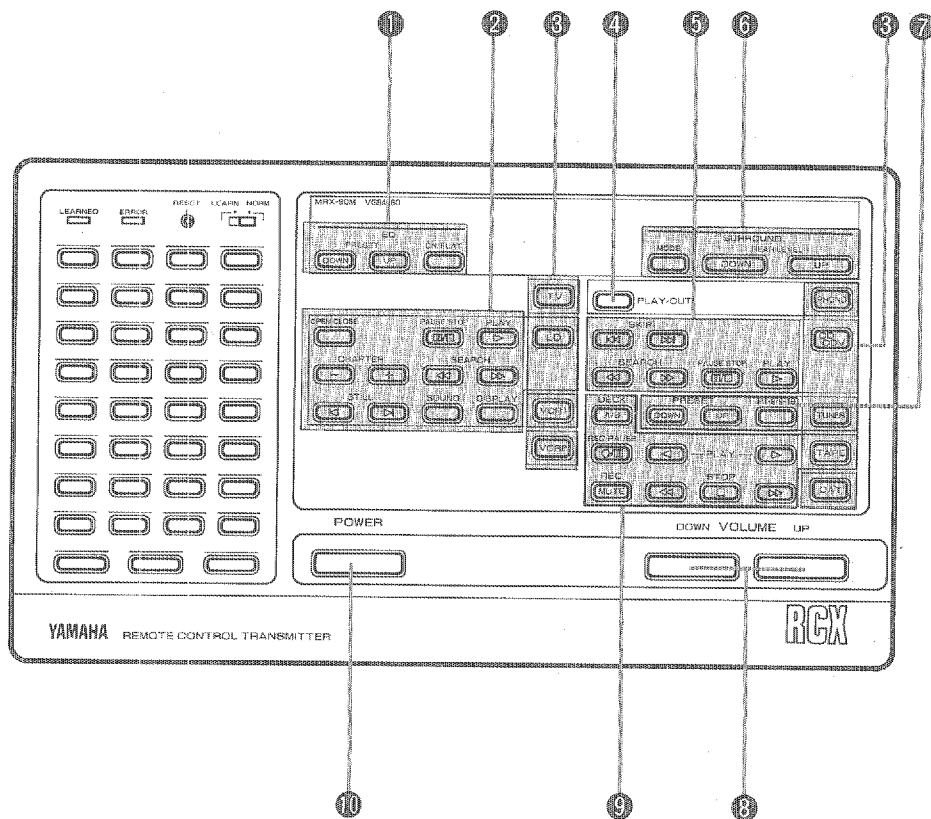

① Graphic Equalizer section

These keys are used to operate the YAMAHA graphic equalizer (EQ-90M) connected to the system.

ON/FLAT

Press this key to select operation of equalizer (EQ ON), or non-operation (FLAT).

UP

When this key is pressed, the preset memory equalizer curve will be called in the order: 1 → 2 → 3 7 → 8 → 1.

DOWN

When this key is pressed, the preset memory equalizer curve will be called in the order: 8 → 7 → 6 2 → 1 → 8.

② LD player section

These keys are used to operate the YAMAHA LD player.

OPEN/CLOSE

Press this key to open/close the disc tray.

PAUSE/STOP

Press this key once to temporarily stop the player operation. When it is pressed again, the player enters stop mode.

PLAY

Press this key to start play. If this key is pressed when the disc tray is opened, the disc tray will close and the unit will enter play mode. When this key is pressed during other modes (pause, still, etc.) that mode is released and play is resumed.

CHAPTER

Press the — key to detect the beginning of the current chapter. If it is kept pressed, the chapter number is reversed continuously.

Press the + key to detect the beginning of the next chapter. If it is kept pressed, the chapter number is advanced continuously.

SEARCH

When the ◀◀ key is pressed during play, play is reversed at high speed.

When the ▶▶ key is pressed during play, play is advanced at high speed.

STILL

When one of these keys is pressed during LD (CAV) disc play, the picture freezes. Every time the ◀◀ key is pressed again, the picture reverses frame-by-frame.

Every time the ▶▶ key is pressed again, the picture advances frame-by-frame.

SOUND

Every time this key is pressed, the audio signal changes in the order. STEREO → 1/L-CH → 2/R-CH → STEREO.

DISPLAY

When this key is pressed during play, the monitor screen shows the following data.

With LD (CAV) discs:

Chapter and frame numbers

With LD (CLV) discs:

Chapter and time

With CD discs or the audio section of CDV discs:

Total time, remain time or track time

With the video section of CDV discs:

Track/index numbers and track time

③ Input selector keys

Select the desired program source with these keys (PHONO, CD/CDV, TUNER, TAPE, DAT, TV, LD, VCR1, VCR2).

④ Turntable section

This key is used to start and stop record play on the turntable (P-90M) connected to this unit. This key functions same as the PLAY/CUT key on the turntable. Pressing this key starts record play and pressing it again stops play.

⑤ CD/CDV player section

The compatible YAMAHA CD player (CD-90M or bearing the RS mark) can be controlled directly with the remote control transmitter.

PAUSE/STOP

Used to set the player to pause or stop mode. Pressing the key once pauses temporarily and pressing it again stops play.

PLAY

Press this key to start play.



Press to advance to the beginning of the next tune.



Press to return to the beginning of the current tune. When this key is pressed at the beginning of the tune, play will start at the beginning of the previous tune.



Press to audibly fast forward the tune.



Press to audibly fast rewind the tune.

⑥ Surround control section

These key are used to control the surround functions integrated in the AV selector (AVS-90M).

MODE

Press this key to select surround mode (DOLBY, NATURAL).

REAR LEVEL (UP/DOWN)

Press this key to adjust rear speaker volume.

Press UP to increase volume, and press DOWN to reduce volume.

⑦ Tuner section

These keys are used to select the broadcast station presets on the tuner (T-90M) connected to this unit.

P1-8 9-16

Press this key to switch preset station selection 1-8, or 9-16.

UP

When this key is pressed, the preset station will be called in the order: 1(9) → 2(10) → 3(11) 7(15) → 8(16) → 1(9).

DOWN

When this key is pressed, the preset station will be called in the order: 8(16) → 7(15) → 6(14) 2(10) → 1(9) → 8(16).

⑧ VOLUME control keys

These keys are used to adjust the volume level heard from the speakers connected to this unit.

⑨ Tape deck section

These keys are used to operate the double cassette deck (K-W90M) connected to this unit.

DECK A/B

Press to select the deck to be operated between the deck A and B on the double cassette deck.

REC PAUSE

Press this key once during STOP for Record/Pause condition. Press the PLAY key to begin recording.

When this key is pressed during recording, Record/Pause will resume.

PLAY

Press the start tape play on the last playing deck.

When this key is pressed during Record/Pause, Record will resume.

REC MUTE

Press to make a non-recorded section during recording.



Press to rewind the tape.

STOP

Press to stop the tape.



Press to fast forward the tape.

⑩ POWER key

Press this key to turn the amplifier ON and OFF.

This remote control transmitter has a learning function.

For details, refer to the "How to use the learning function" section described later.

OPERATIONS

● Basic Operations

1. Set ⑦ Volume to the lowest (0) position and switch power of each units ON.
2. Set ② Speaker switch (SPEAKERS) to desired position. Turn switch ON when listening to speakers, and turn switch OFF when listening to headphones only.
3. Select source to be listened to with ④ Input selector. The indicator of the selected source will light above the button.
4. Play source.
5. Adjust ⑧ Volume, ⑩ Balance Control knob (BALANCE), ⑪ Treble Control knob (TREBLE), and ⑫ Bass Control knob (BASS) while listening to sound.
When listening with low volume, turn ON ⑬ Dynamic Sound switch (DINAMIC SOUND) for easy listening.

● Source Recording

1. Conduct operations of the aforementioned (Basic Operations), and select desired source to be recorded with ④ Input selector. Make sure that ① Rec Out selector (REC OUT) is set in the Source position.
 2. Play Source.
 3. Operate tape deck or DAT deck and record.
 4. Select TAPE or DAT with ④ Input selector according to deck to be played, when playing recorded sound.
- * Volume and tone controls do not affect sound to be recorded.

● Tape Dubbing

1. Select with ① Rec Out selector (REC OUT).
Set to TAPE position when dubbing from tape deck to DAT deck. Set to DAT position when dubbing from DAT deck to tape deck.
 2. Play with Source-side deck, and begin recording with Recording-side deck.
 3. Other sources can be listened to while dubbing.
Select source to be listened to with ④ Input selector. When listening to sound that is being dubbed, select TAPE or DAT according to the deck being played with ④ Input selector.
- * Volume, tone controls, as well as selecting of inputs do not affect dubbing.

USING THE REMOTE CONTROL TRANSMITTER

The remote control transmitter supplied with your amplifier is designed to control all the most commonly used features of the amplifier. If the CD player tuner, turntable and cassette deck connected to your amplifier are YAMAHA components designed for remote control compatibility, then this remote control transmitter will also control various functions of each component. Please consult your YAMAHA dealer for information on which components are compatible with the remote control transmitter. Note that this Remote Control will directly operate any compatible YAMAHA CD player with RS mark.

■ Battery Installation

The remote control unit uses 4 batteries (size "AA", R06). Install them according to the following illustration. Be sure that they are installed correctly.

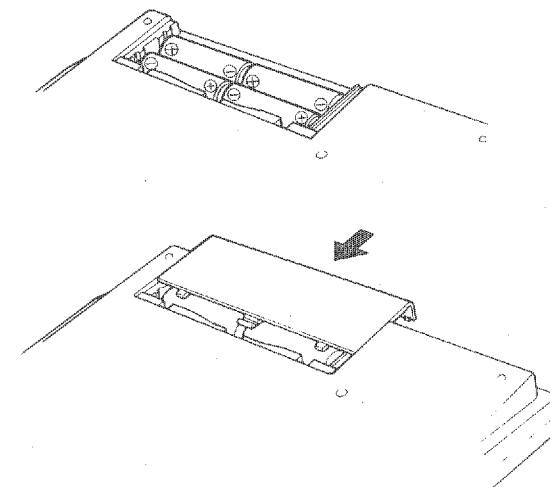

■ Battery Replacement

When the remote controllable distance becomes short, the batteries are very weak. Replace the 4 batteries with new ones.

Battery cautions

Incorrect use of a battery may cause leakage or an explosion. Be careful of the following items:

When replacing:

- Place the batteries in correct (+) and (−) polarities as indicated in the battery compartment.
- Do not use an old battery with a new one.
- Do not use different kinds of batteries at the same time, even though of the same shape.

Use with the remote control transmitter:

- When the remote control transmitter is not in use for an extended period of time, remove the batteries from it.

To prevent accidents:

- Never disassemble, heat a battery, or throw it into a fire. Dispose of batteries in specified places.
- Do not connect (short) the (+) and (−) terminals directly with a metal piece, etc.
- There are two kinds of batteries on the market; rechargeable and non-rechargeable. Read the caution labels on the batteries carefully.

In case of leakage:

Wipe off the electrolyte in the battery compartment completely before replacing with new batteries.

■ Operation Range

You must point the remote control unit toward the amplifier and be within about 7 meters (23 feet) of it for proper operation.

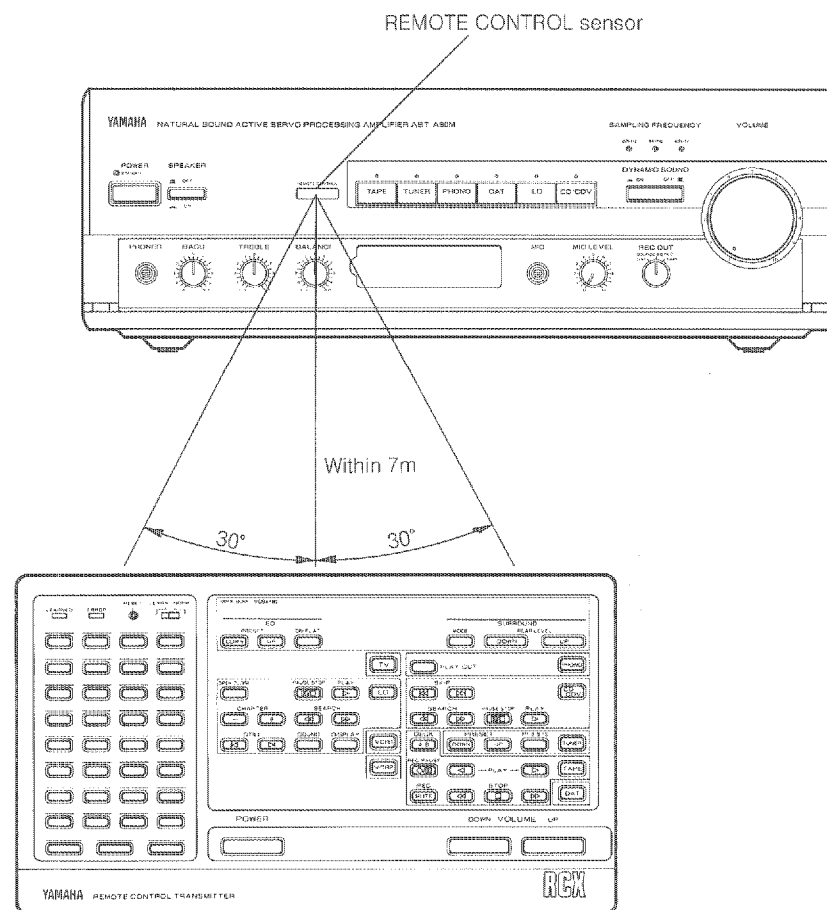

HOW TO USE THE LEARNING FUNCTION

The supplied remote control transmitter is a "learning" remote control unit that allows for centralized control of various Audio/Visual equipment, solving the complicated problem of operating several remote controllers for your system.

NOTES

- If the indicators are only dimly lit when pressing a key, the batteries are weak. Replace the batteries.
- All memorized functions will be retained while you replace the batteries. However, if no batteries are installed for an hour, the memory will be erased and will have to be programmed again.

Controls and Functions

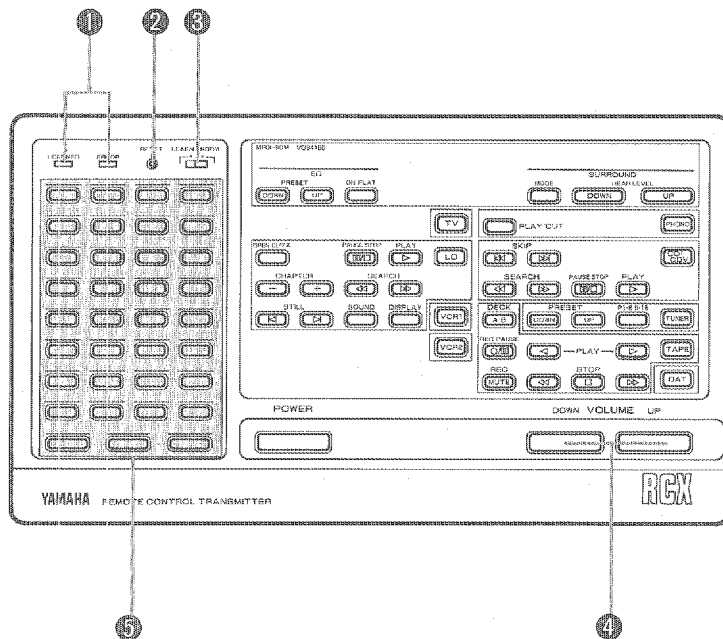

① LEARNED and ERROR Indicators

These indicators show the operation mode of the remote control transmitter.

② RESET button

Used to clear a programmed signal.

③ NORM/LEARN switch

This switch is used to select between LEARN (program) and NORM (control) modes.

④ Preset/learning keys

These keys have already been preset with signals for controlling YAMAHA audio equipment (with the RS mark).

However, if desired, other signals can be "learned" by these keys (over the preset signals), in the same way as for the ordinary learning keys.

⑤ Learning keys

These keys can be used to "learn" (program) signals from another remote controller.

Operations

To program the signals of another remote controller in the learning remote control transmitter, please follow the steps below.

1. Switch the NORM/LEARN switch to the LEARN position.



2. Position the learning remote control transmitter and the remote control unit to be memorized head to head.

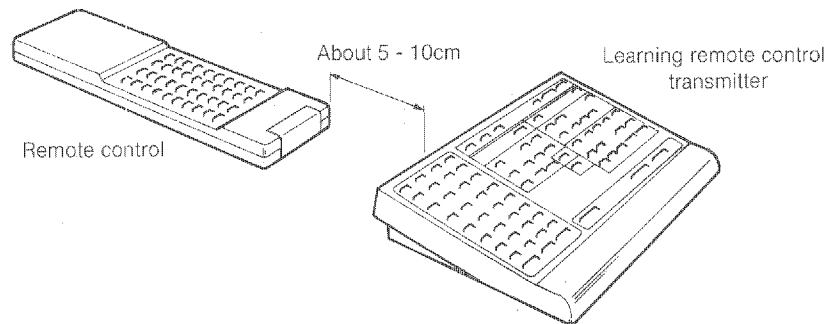

3. Select and press the learning or preset/learning key on the learning remote control transmitter to be programmed.

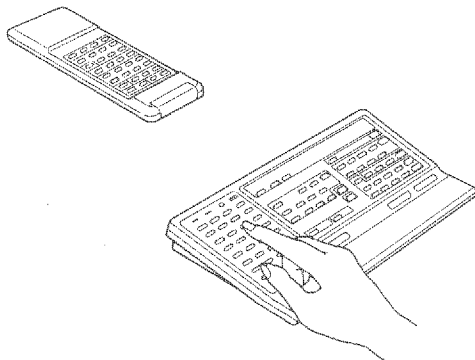

The LEARNED indicator will flash for about 15 seconds.

If the ERROR indicator lights up when the key is pressed, a signal has already been programmed in that key. If the programmed signal can be replaced, proceed to the next step.

If the programmed signal cannot be replaced, press another learning or preset/learning key on the learning remote control transmitter.

4. While the LEARNED indicator is flashing, press a key on the other remote controller.

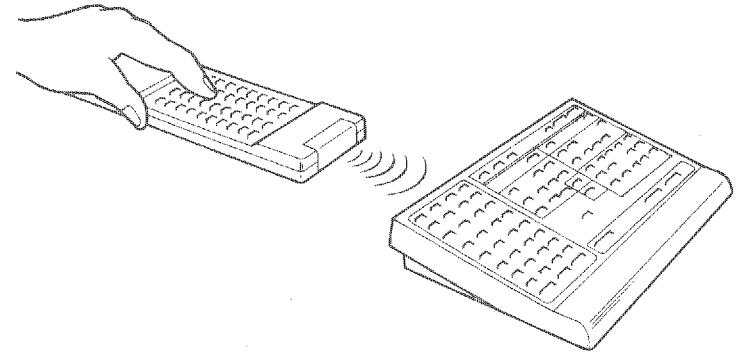

The LEARNED and ERROR indicators will light steadily while receiving the signal. Press the other remote controller's key until these indicators turn off.

The LEARNED indicator will light for about 2 seconds when the memorization of a function is successfully completed.

The ERROR indicator will light for about 2 seconds when the memorization of a function is unsuccessful. In this case, please try again.

5. Repeat steps 3 and 4 until all programming is complete.
6. Once programming is complete, set the NORM-LEARN switch to the NORM position.



7. Use the supplied seals to indicate the functions for which the learning and preset/learning keys have been programmed.

It is recommended that you first determine the best and most convenient layout of the keys for the various functions you plan to program and attach the seals accordingly, then program the keys correspondingly.

If programming is not carried out successfully, or if the remote control operation is not successful although programming was successful, check the following:

- Are the batteries of the other remote controller weak?
In this case, even when the other remote controller can operate the unit, its signal strength is too weak for the learning remote control transmitter. Replace the batteries of the other remote controller.
- Is the distance to the other remote controller too small or too large, or are they not in line?
- Is a strong light, such as direct sunlight, incident on the learning remote control transmitter?

If the signal to be stored is too long.

When the signal to be stored is too long, the learning remote control transmitter automatically enlarges the work area capacity and stands by for a second entry. Please try the storage operation again.

NOTE:

- Some remote controllers may not be able to conduct learning operations.

To Erase a Programmed Signal

To erase a signal programmed on a learning key or a preset/learning key, proceed as follows.

1. Set the LEARN/NORM switch to the LEARN position.
2. Press the RESET button.

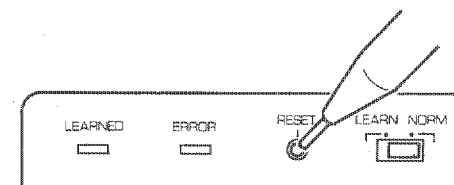

The LEARNED and ERROR indicators will flash for about 15 seconds.

3. While the LEARNED and ERROR indicators are flashing, press the learning or preset/learning key for which you want the programmed signal to be erased.
The ERROR indicator will turn off, and then the LEARNED indicator will light up for about 1 second to indicate the completion of the erasure. For the preset/learning keys, your programmed signal is erased and the originally preset signal resumes.
4. Repeat steps 2 and 3 for other keys, if necessary.

TROUBLESHOOTING

When this unit will not function normally during operations, check the following items. Turn OFF POWER switch of this unit, unplug power cord and contact retail store where purchased, should this unit not function normally upon conducting the following check or should irregularity other than those described below exists.

SYMPTOM	POSSIBLE CAUSE	APPROPRIATE REMEDY
Power will not turn on, even when POWER is ON.	Power plug connection is poor.	Check power cord connection.
No sound	Ⓒ Speaker switch (SPEAKERS) is turned OFF.	Turn ON or listen with headphones.
	Speaker connection is poor.	Check speaker cord connection.
	AST cartridge is not inserted into Ⓓ cartridge holder.	Insert AST cartridge (attached to AST speaker). When using conventional speakers, insert AST cartridge (attached to this unit.)
Sound emitted only from one side of speakers	Ⓔ Balance control knob (BALANCE) is fully turned to the right or left.	Adjust so that sound will be balanced in the L/R speakers.
	Speaker connection is poor.	Check speaker cord connection.
Sound is emitted but bass is unsatisfactory	Speaker cord + and - is incorrectly connected.	Correctly connect + and -.
There is a hum noise when record is playing.	Input terminal connection is poor.	Check pin-plug connection.
	Turntable ground is not connected to ground terminal of this unit.	Connect ground.
Howling occurs when record is playing.	Phenomenon when vibrations from the speakers is transmitted to the turntable.	Change position of speakers and turntable or reduce volume.

When the remote control will not function normally, check the following items.

CONDITION	INDICATOR	CAUSE	REMEDY
Will not enter into memory	ERROR lights for 2 seconds.	Signal may contain noise.	Repeat memory operations once again.
		The other remote controller's batteries may be weak.	Replace batteries.
		When the other remote controller's signal is long or when the modulation is different, the learning remote controller will extend its processing capacity and will enter standby condition on the next signal. In this case, after the ERROR indicator lights, the LEARNED indicator will flash rapidly.	Repeat memory operations once again.
	LEARNED, ERROR flashes twice.	Memory capacity may be full.	Further memory is not possible. Erase unnecessary memory And enter memory once again.
	Nothing lights when the key is pressed.	Batteries may be dead.	Replace batteries.
Will enter into memory, but other units will not operate.		Noise other than signal may have entered into memory.	Repeat memory operations once again.
		Incorrect signal may have entered into memory. Please caution against immediate power OFF after power ON when signal such as the power switch is rapidly pressed twice and has entered into memory.	
		The remote sensor signal range of the other unit may be weak.	Go closer to the other unit and operate.
		Can not adjust volume and video fast forward playback, etc., continuous operation. Only sends single signal at a time.	Keep on pressing the key of the other remote controller until LEARNED, ERROR indicator lights during memory operations.
		Some remote controllers may not be able to conduct learning operations.	

SPECIFICATIONS

Minimum RMS Output Power Per Channel	
20Hz-20kHz 0.09% THD, 6 ohms	45W
Dynamic Power Per Channel (IHF, 6 ohms)	
Dynamic Headroom (6 ohms)	1.25 dB
Input Sensitivity/Impedance	
PHONO MM	2.5 mV/47k-ohms
CD/CDV/LD/TAPE/TUNER/DAT	150 mV/47k-ohms
Input Sensitivity (New IHF)	
PHONO MM	0.37 mV
CD/CDV/LD/TAPE/TUNER/DAT	22 mV
Maximum Input Level	
1kHz, 0.1% THD, PHONO MM	60 mV
Output Level/Impedance	
REC OUT	150 mV/470 ohms
Phones Jack Output Level/Impedance	
0.09% THD, 8 ohms	100 mV/150 ohms
Frequency Response (20 Hz to 20 kHz)	
CD/CDV/LD/TAPE/TUNER/DAT	±0.5 dB
RIAA Equalization Deviation	
PHONO MM	±0.5 dB
Total Harmonic Distortion (20 Hz to 20 kHz)	
PHONO MM (2V)	0.005%
CD/CDV/LD/TAPE/TUNER/DAT to SP OUT (25W/6 ohms)	0.008%
Signal-to-Noise Ratio (IHF-A-Network)	
PHONO MM (5 mV Input Shorted)	80 dB
CD/CDV/LD/TAPE/TUNER/DAT (Shorted)	92 dB
Residual Noise (IHF-A-Network)	250 μ V
Channel Separation	
PHONO MM Input Shorted (1 kHz/10 kHz)	60 dB/50 dB
CD/CDV/LD/TAPE/TUNER/DAT Input 5.1k-ohms Terminated (1 kHz/10 kHz)	60 dB/50 dB
Tone Control Characteristics	
BASS boost/cut	±6 dB at 50 Hz
TREBLE boost/cut	±10 dB at 20 kHz

Power Supply

USA and Canada models	AC 120 V, 60 Hz
Europe model	AC 220 V, 50 Hz
UK and Australia models	AC 240 V, 50 Hz
General model	AC 110/120/220/240 V, 50/60 Hz

Power Consumption

USA, Canada and General models	195W
Europe, UK and Australia models	300W

AC OUTLETS (USA, Canada and General models)

SWITCHED×3	TOTAL 100W
Dimensions (W×H×D)	366×124×328 mm
	(14-3/8"×4-7/8"×12-7/8")

Weight 6.7 kg (14 lbs. 12 oz.)

Attached Items Owner's Manual, Learning Remote Control
Transmitter "AA" batteries (×4),
AST Cartridge (AST-K90M)

* Specifications and appearance may be changed without notice
due to continuous progress in development.

YAMAHA
HAMAMATSU, JAPAN